

1550nm DFB Butterfly Laser Diode

5-60mW, 0.2nm, integrated with isolator and monitor



DATASHEET

[Return to the Webpage](#)

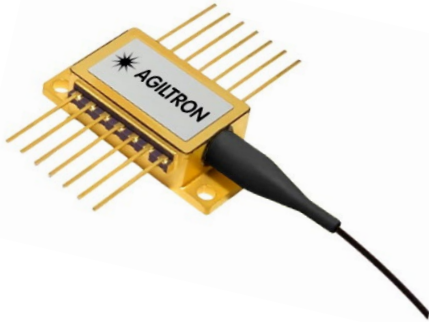

Features

- Built-in Optical Isolator
- Low Capacitance
- High Stability of DFB Structure
- Integrated Tap Monitor

Applications

- Instrument
- Analog/Digital Transmission



The DFBD series fiber-coupled laser diodes are designed with a GaAs quantum well structure integrated with a grating configuration. These diodes feature a built-in photodiode for precise monitoring and feedback control of the laser's output power. Housed in standard TO packages, these diodes are pigtailed to a 1-meter long single-mode fiber terminated with an FC/APC connector. Each unit undergoes rigorous testing prior to shipment to ensure reliability.

Additionally, we offer a cost-effective, high-performance feedback control driver kit that maintains constant and adjustable output power, along with an externally cooled mounting fixture to stabilize the output wavelength. It is available in module or benchtop.

Specifications

Parameter	Min	Typical	Max	Unit
Operating Case Temperature	-20		65	°C
Storage Temperature	-40		70	°C
Laser Forward Current	-		150	mA
Laser Reverse Bias	-		1	V
Photodiode Reverse Bias	-		10	V
TEC Current	-2		+2	A
TEC Voltage	-2.5		+2.5	V
Thermistor Temperature	-20		65	°C
ESD	-500		+500	V
Lead Solder Temperature	-		260	°C
Lead Soldering Time	-		10	S
Environmental Operating Humidity	-		95	%
Environmental Storage Humidity	-		95	%
Fiber Bend Radius	-		20	mm
Fiber Yield Strength	-		1	kgf
Optical & Electrical Characteristics				
Center Wavelength	1540	1550	1560	nm
Spectral Width (-20dB)	-	0.2	0.5	nm
Optical Output Power	-	10	60	mW
Optical Isolation	30	35	-	dB
Side-mode Suppression Ratio	30	35	-	dB
Threshold Current	-	5	15	mA
Operating Current	-	-	100	mA
Forward Voltage	-	1.2	2.0	V
Monitor Current	100	-	1500	µA
Monitor Dark Current	-	-	100	nA
Operating Case Temperature	-20	-	60	°C
Tracking Error	-1	-	1	dB
Thermistor Resistance	9.5	-	10.5	KΩ
Thermistor B Constant	-	3900	-	K
TEC Current	-	-	1.0	A
TEC Voltage	-	-	2.0	V
Cut-off Frequency	4	-	-	GHz
Frequency Range	45	-	2500	MHz

Note: The specifications provided are for general applications with a cost-effective approach. If you need to narrow or expand the tolerance, coverage, limit, or qualifications, please [click this link](#):

Rev 10/03/24

© Photonwares Corporation

[+1 781-935-1200](tel:+17819351200)

sales@photonwares.com

www.agiltron.com

1550nm DFB Butterfly Laser Diode

5-60mW, 0.2nm, integrated with isolator and monitor



DATASHEET

Mechanical Dimension (mm)

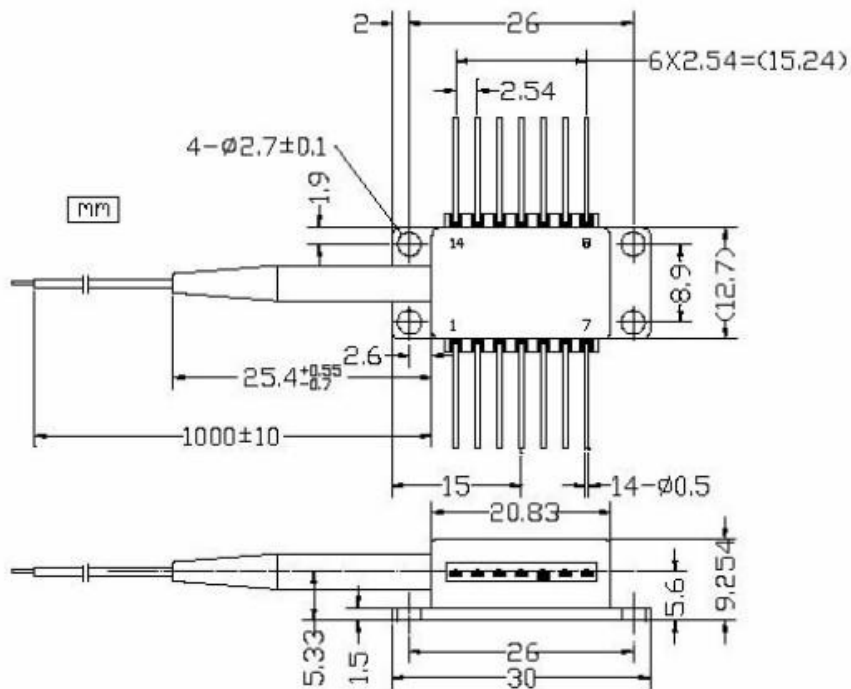

*Product dimensions may change without notice. This is sometimes required for non-standard specifications.

PIN Assignment

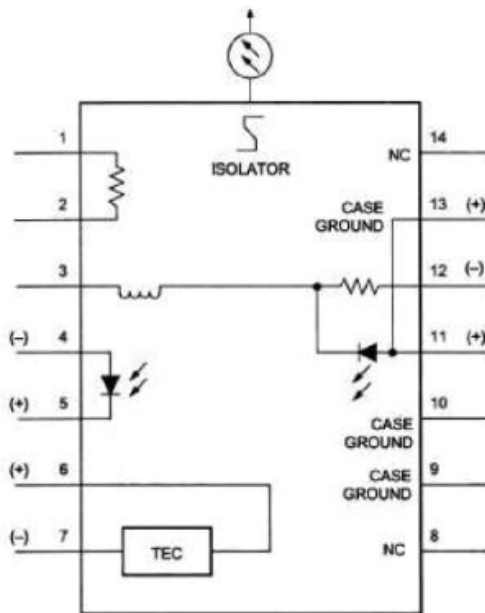

14-pin BTF Package

PIN	Function
1	Thermistor
2	Thermistor
3	LD (-)
4	MPD (-)
5	MPD (+)
6	TEC (+)
7	TEC (-)
8	NC
9	Case
10	Case
11	LD (+), Case
12	LD (-), RF
13	LD (-), Case
14	NC

1550nm DFB Butterfly Laser Diode

5-60mW, 0.2nm, integrated with isolator and monitor



DATASHEET

Typical Spectrum

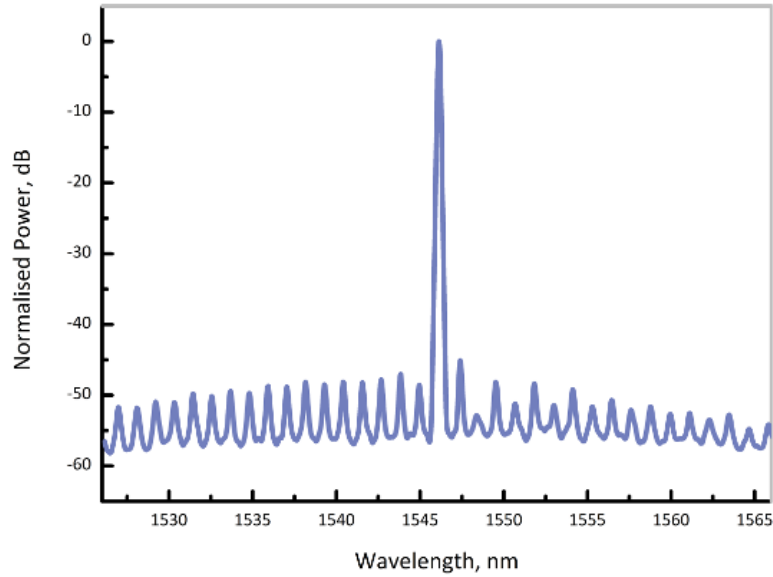

Ordering Information

Prefix	Wavelength	Output Power	Linewidth	TEC Cooling	Package	Fiber Type	Fiber Buffer	Fiber Length	Connector
DFBD-	1550nm = 55 Special = 0	>5mW = 5 >15mW = A 60mW = F	0.2nm = 1	Yes = 2	Type 1 = 1	SM28 = 1 PM1550 = 5 PM1310 = 3 Special = 0	0.9mm Tube = 3 Special = 0	1.0 m = 1 Special = 0	FC/APC = 3 Special = 0

1550nm DFB Butterfly Laser Diode

5-60mW, 0.2nm, integrated with isolator and monitor



DATASHEET

Benchtop Matching Laser Diode Driver



Agiltron cost-effective LDCB series benchtop control kit is designed for easy laser diode mounting and precise control. It incorporates a high-precision, low-noise auto-feedback drive electronics to ensure constant output power or a constant driving current and an integrated temperature control unit maintains optimal operating conditions. The system provides up to 1A driving current and up to 2A TEC cooling current. Each system features a front fiber output connector. The user interface includes an intuitive LCD display for independent control of output power and temperature via two front rotating knobs. The LDCB also includes a universal power supply compatible with 100 to 240 VAC. The LDCB has a built-in isolator option to prevent reflection-induced laser emissions instability. The LDCB is designed as a laser diode and TEC controller kit for customer to install laser diode. It has three types of pluggable laser mounts of butterfly, DIL, and TOCAN. The TOCAN mount contains an external TEC that maintains a constant temperature for wavelength stability.

For details please click: <https://agiltron.com/product/laser-diode-tec-controllers-benchtop-kit/>

Turn-Key Module Matching The Laser Diode



The Agiltron LDCM series laser source module is designed for OEM applications and features all-in-one high reliability and highly stable laser output. The LDCM contains high-precision, low-noise, auto-feedback laser diode drive electronics to ensure constant output power or driving current and an integrated temperature controller that maintains optimal operating conditions. An optional fiber optical isolator can be integrated to prevent reflection-induced laser emission instability, which is essential for achieving highly stable lasers. Agiltron produces isolators from 370nm to 2600nm. The system provides up to 1A driving current and up to 2A TEC cooling current. Each unit features a single FC/APC connector output and two front rotating knobs for independent setting of laser output power and temperature. A toggle switch allows selection between constant current control mode and feedback constant output power mode.

For details please click: <https://agiltron.com/product/laser-diode-tec-controllers-module/>

Laser Driver Kit



Agiltron cost-effective LDCD series module control kit is designed for easy laser diode mounting and precise control. It incorporates a high-precision, low-noise auto-feedback drive electronics to ensure constant output power or a constant driving current and an integrated temperature control unit maintains optimal operating conditions. The system provides up to 1A driving current and up to 2A TEC cooling current. It has three types of pluggable laser mounts of butterfly, DIL, and TOCAN. The TOCAN mount contains an external TEC that maintains a constant temperature for wavelength stability. It comes with cables to connect between the mounting module to the driving module, making integration convenient.

For details please click: <https://agiltron.com/product/laser-diode-tec-controllers-compact/>

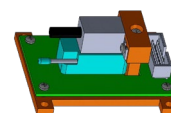
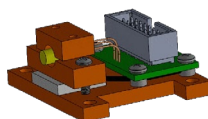
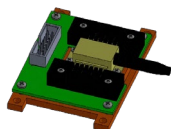

1550nm DFB Butterfly Laser Diode

5-60mW, 0.2nm, integrated with isolator and monitor



DATASHEET

Caution Electrostatic Sensitivity



- Never touch laser diode and the module using hands
- Always use protections when handle a laser diode
- Recommend mounting the laser diode using an ionic gun and ESD finger cots



Laser Safety

This product meets the appropriate standard in Title 21 of the Code of Federal Regulations (CFR). FDA/CDRH Class 1M laser product. This device has been classified with the FDA/CDRH under accession number 0220191. All versions of this laser are Class 1M laser products, tested according to IEC 60825-1:2007 / EN 60825-1:2007. An additional warning for Class 1M laser products. For diverging beams, this warning shall state that viewing the laser output with certain optical instruments (for example eye loupes, magnifiers, and microscopes) within a distance of 100 mm may pose an eye hazard. For collimated beams, this warning shall state that viewing the laser output with certain instruments designed for use at a distance (for example telescopes and binoculars) may pose an eye hazard.

Wavelength = 1.3/1.5 μm .

Maximum power = 30 mW.



*Caution - Use of controls or adjustments or performance of procedures other than those specified herein may result in hazardous radiation exposure.

*IEC is a registered trademark of the International Electrotechnical Commission.