

Erbium Doped Fiber Amplifier: C-Band (1528 – 1565nm)



DATASHEET

[Return to the Webpage](#)



Agiltron Erbium-doped fiber amplifier (EDFA) provides cost-effective solutions for high-power optical amplification. It is built using semiconductor lasers, WDM, isolator, and erbium-doped fiber. The product has the advantages of high reliability, high power output, high gain, and low noise. Two configurations are available: A preamplifier for slight optical signal amplification and a Booster amplifier for maximum output power. We make both random polarization and polarization maintain versions. It has several package configuration choices. A Benchtop unit that is preset at the highest gain is suited for laboratory use. The Benchtop has a computer control interface and GUI. The compact module is suited for system integration with the universal control interface. The pluggable and the associated host net-control rack are standardized for local network build-out. Customer configurations are available.

The EDFAs have both ACC mode – automatic current control or constant current control and APC mode – automatic power control settable via GUI. In the ACC mode, the pump laser's current is set by the user and automatically locked by the EDFA to achieve a constant pumping current. The EDFA's output power is proportional to the input power and has output even though the input signal is weak. In the APC mode, the user sets the output power, and the EDFA automatically maintains the output constant in a feedback laser pump control way. When the input optical power fluctuates, the APC mode minimizes the fluctuation of the output power and is suitable for power type and line type EDFA.

The bench top or rack mount units can have multiple output channels in which the output is equally split into multiple outputs.

The EDFA has isolators on both input and output.

These Erbium-Doped Fiber Amplifiers (EDFAs) are engineered for a long operational lifespan, typically designed to function reliably for over 10 years. This durability is achieved through high-quality components and robust manufacturing processes. The design considerations include thermal management, component selection, and rigorous testing to maximize the amplifier's longevity and efficiency.

Features

- Low Noise
- High Output Up to 41dBm
- High Stability
- High Reliability
- Customizable

Applications

- BOTDR
- OTDR
- LiDAR
- Fiber sensing

Specifications

Parameter		Min	Typical	Max	Unit
Wavelength		1528	1550	1565	nm
Input Power	Booster	-23	0	12	dBm
	Pre	-30	-20	5	dBm
Output Power	Booster			22	dBm
	Pre			16	dBm
Optical Gain	Booster			24	dBm
	Pre			26	dBm
Noise Figure			5 [6]		dB
Gain Flatness			1		dB
Polarization Dependent Gain [4]				0.3	dB
Polarization Mode Dispersion [4]			0.5		Ps
Input/output Isolation		35			dB
Output Stability (8hrs)			0.05	0.1	dB
Adjustable Output Power			Yes with AGC		
Fiber Type		SMF-28e 9/125um NA = 0.13			
Working Temperature [1]		-30	40	70	°C
Storage Temperature		-40		85	°C
Power Consumption				25	W
Power Supply	<23dBm (MSA)		DC +5		V
	≥23dBm		DC +12		V
Communication		USB / RS232/Ethernet SNMP			

Notes:

[1]. The regular range is -5 to 40°C, for extended range requires additional cost

Note: The specifications provided are for general applications with a cost-effective approach. If you need to narrow or expand the tolerance, coverage, limit, or qualifications, please [click this link](#):

Legal notices: All product information is believed to be accurate and is subject to change without notice. Information contained herein shall legally bind Agiltron only if it is specifically incorporated into the terms and conditions of a sales agreement. Some specific combinations of options may not be available. The user assumes all risks and liability whatsoever in connection with the use of a product or its application.

Rev 10/28/24

Erbium Doped Fiber Amplifier: C-Band (1528 – 1565nm)



DATASHEET

Function Diagram

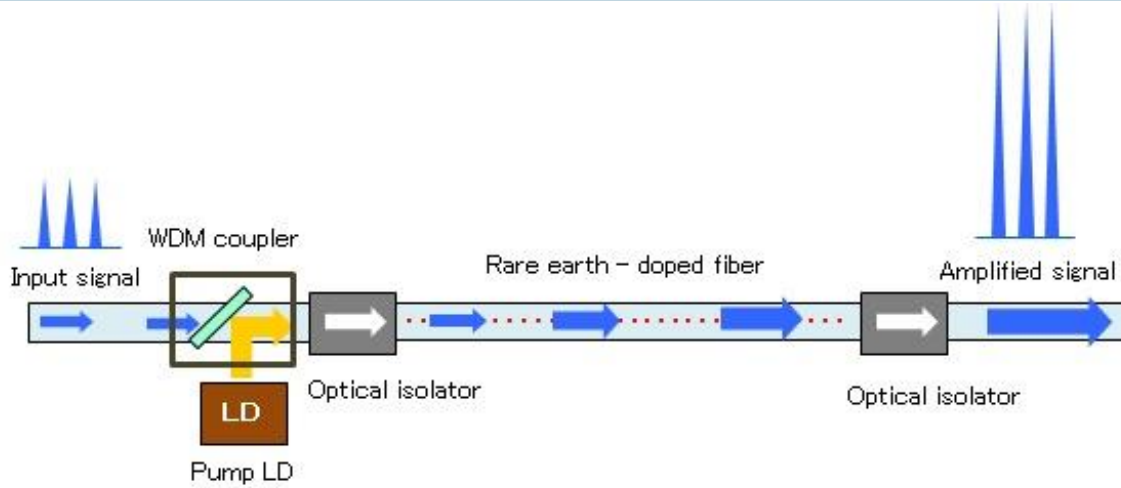

Package Choices



Component



Benchtop- USB/GUI

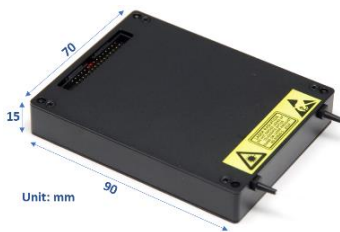

MSA



MSA USB/GUI Adapting PCB

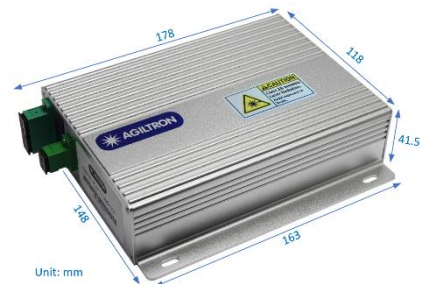

Mini benchtop



Pluggable



Net-Control Rack

Erbium Doped Fiber Amplifier: C-Band (1528 – 1565nm)



DATASHEET

GUI USB Interface

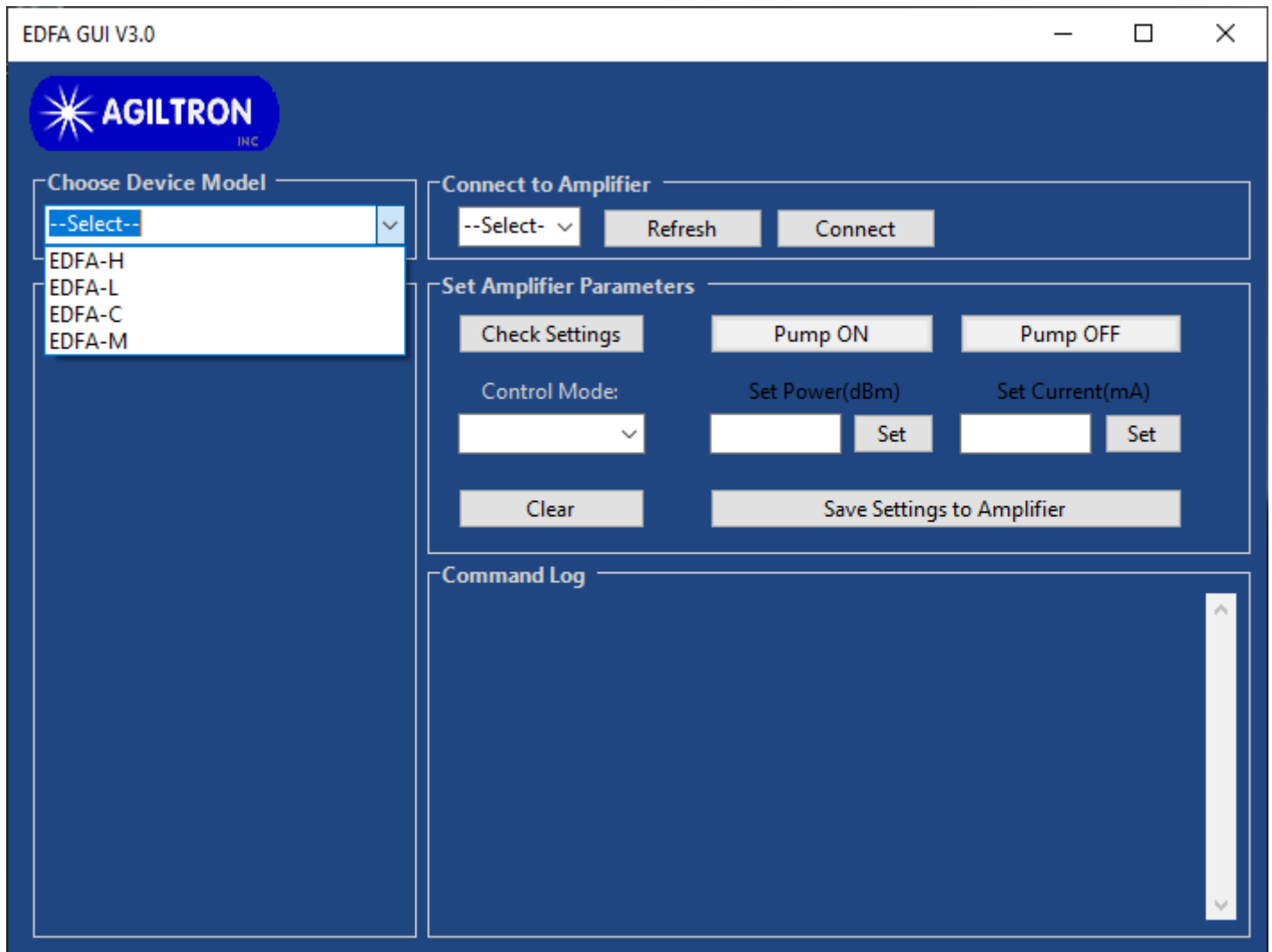

Operation Instruction

- Load the software, Unzip the folder and Click "setup" to Install the GUI
- Select an amplifier type that matches your PO
- Connect your PC to the Amplifier by first connecting a USB cable and then choosing the necessary port and clicking "Connect". To change the COM port click "Refresh", choose the necessary port, then click "Connect"
- Obtain the stored settings by clicking "Check Settings"
- To change the setting, first select the control mode
- To set up output power or current, input desired value and click "Set". There are limits for max output per the model type.
- To turn on the Amplify click "Pump ON"; the green color should appear. To stop click "Pump OFF"; the red color should appear
- To save the setting click "Save Settings to Amplifier". The Amplifier will store the setting for the next time you turn it on, even without the PC.
- The Amplifier only works if the input optical power level is within the spec.

Erbium Doped Fiber Amplifier: C-Band (1528 – 1565nm)



DATASHEET

Control GUI

Erbium Doped Fiber Amplifier: C-Band (1528 – 1565nm)



DATASHEET

Output Power Stability (33dBm Benchtop)

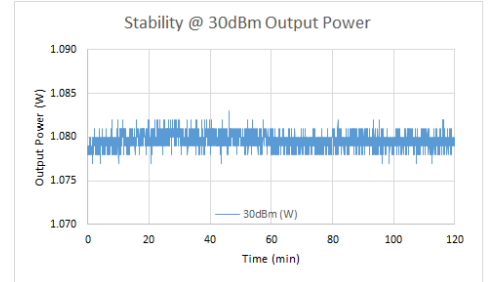
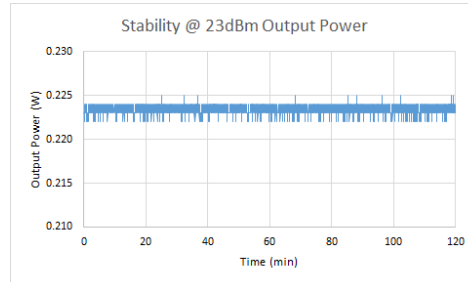
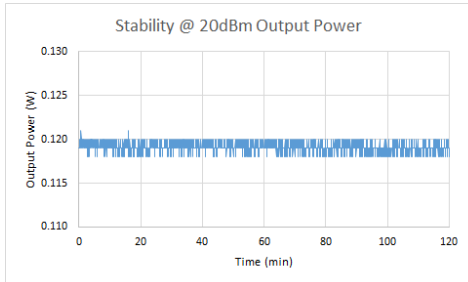

Mechanical Dimensions (mm)

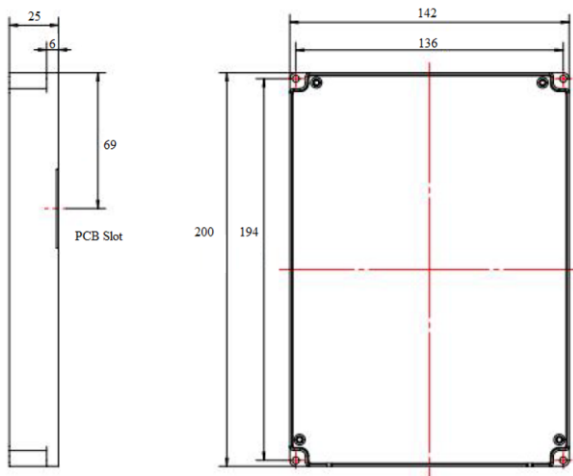

High-power: >23dBm

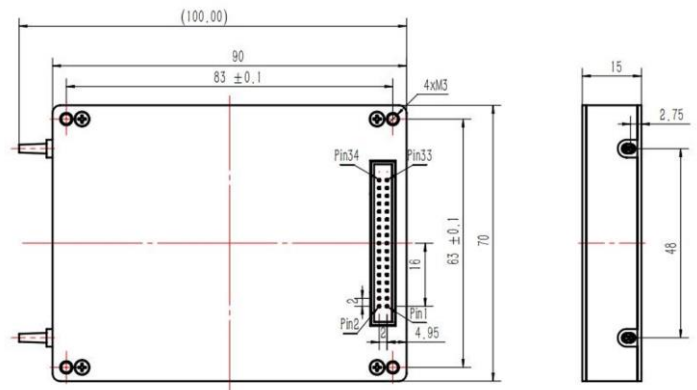

MSA package: 20dBm

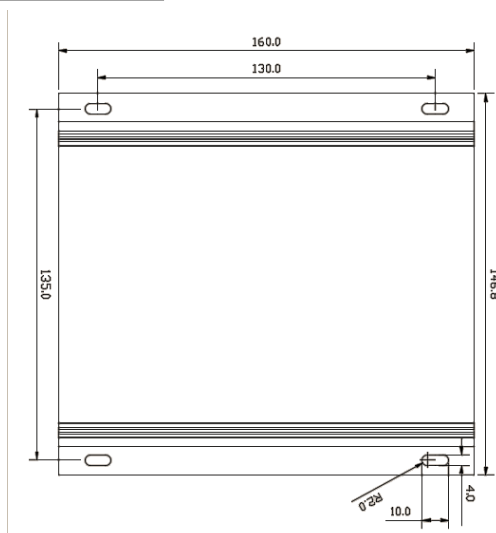

Mini Benchtop: 17/20dBm

*Product dimensions may change without notice. This is sometimes required for non-standard specifications.

Erbium Doped Fiber Amplifier: C-Band (1528 – 1565nm)



DATASHEET

Electrical Information For SMA Package

1. Power Supply

Parameter	Min	Typical	Max	Unit	Note
Voltage	4.75	5.0	5.25	V	
Current	-	-	3.0	A	
Power Consumption	-	-	15	W	

2. Pin definition

Communication Port

Type: 34Pin 2.00mm intervals male socket CJT A2005WV-N-2x17P

Pin definition:

Pin No.	Name	Attribute	Level Type
1	NC	F	
2	NC	F	
3	+5V	P	
4	+5V	P	
5	+5V	P	
6	+5V	P	
7	GND	P	
8	GND	P	
9	NC	F	
10	NC	F	
11	GND	P	
12	GND	P	
13	NC	F	
14	NC	F	
15	NC	F	
16	NC	F	
17	NC	F	

* P: Power, I: Input, O: Output, F: None

Pin No.	Name	Attribute	Level Type
18	NC	F	
19	NC	F	
20	NC	F	
21	NC	F	
22	NC	F	
23	GND	P	
24	GND	P	
25	Serial Port Input	I	LVTTTL
26	Serial Port Output	O	LVTTTL
27	GND	P	
28	GND	P	
29	+5V	P	
30	+5V	P	
31	+5V	P	
32	+5V	P	
33	NC	F	
34	NC	F	

* P: Power, I: Input, O: Output, F: None

Erbium Doped Fiber Amplifier: C-Band

(1528 – 1565nm)

DATASHEET

Ordering Information

Prefix	Type	Wavelength	Power/Gain	Package	Cable Type	Fiber Length ^[3]	Connector	Low Temperature	High Temperature	Control Mode	Filter
EDFA-	Booster = 1 Preamp = 2	C Band = C	10dBm/10mW = A 15dBm/30mW = B 17dBm/50mW = 2 20dBm/100mW = 3 22dBm/160mW = C 23dBm/200mW = D 24dBm/250mW = E 25dBm/320mW = F 26dBm/400mW = G 27dBm/500mW = H 30dBm/1W = 1 33dBm/2W = 5 35dBm/3W = 6 37dBm/5W = 7 40dBm/10W = 8 41dBm/12W = 9 Special = 0	Component = 1 Benchtop = 2 Pluggable = 3 Rack = 4 MSA = M MSA/USB ^[2] = H Special = 0	0.9mm tube = 3 Special = 0	0.25m = 1 0.5m = 2 1.0m = 3 Special = 0	None = 1 FC/PC = 2 FC/APC = 3 SC/PC = 4 SC/APC = 5 LC/PC = 7 LC/APC = A LC/UPC = U Special = 0	-5°C = 1 -30°C = 2 Special = 0	40°C = 1 70°C = 2 Special = 0	APC = 1 ACC = 2 CC ^[3] = 3 Special = 0	None = 1 Gain flat = 2 Special = 0

[1] This is a low-cost version in a mini benchtop package that does not include power adjustment capabilities. For a version with adjustable power, please order the 20 dBm Benchtop model.

[2] The MSA is mounted on a USB-adapting PCB. It comes with a GUI and power supply.

[3] CC (Constant Current) mode keeps the pump laser current at a constant level, ensuring the laser is always on. Unlike APC (Automatic Power Control) and ACC (Automatic Current Control) modes, which only activate the pump laser when the input signal reaches a certain threshold, CC mode can amplify weak signals. However, if the input signal is too low, the amplifier output may be dominated by ASE (Amplified Spontaneous Emission) background noise.

Application Notes

Fiber Core Alignment

Note that the minimum attenuation for these devices depends on excellent core-to-core alignment when the connectors are mated. This is crucial for shorter wavelengths with smaller fiber core diameters that can increase the loss of many decibels above the specification if they are not perfectly aligned. Different vendors' connectors may not mate well with each other, especially for angled APC.

Fiber Cleanliness

Fibers with smaller core diameters (<5 μm) must be kept extremely clean, contamination at fiber-fiber interfaces, combined with the high optical power density, can lead to significant optical damage. This type of damage usually requires re-polishing or replacement of the connector.

Maximum Optical Input Power

Due to their small fiber core diameters for short wavelength and high photon energies, the damage thresholds for device is substantially reduced than the common 1550nm fiber. To avoid damage to the exposed fiber end faces and internal components, the optical input power should never exceed 20 mW for wavelengths shorter 650nm. We produce a special version to increase the handling by expanding the core side at the fiber ends.

Erbium Doped Fiber Amplifier: C-Band (1528 – 1565nm)

DATASHEET

Laser Safety

This product meets the appropriate standard in Title 21 of the Code of Federal Regulations (CFR). FDA/CDRH Class 1M laser product. This device has been classified with the FDA/CDRH under accession number 0220191. All versions of this laser are Class 1M laser products, tested according to IEC 60825-1:2007 / EN 60825-1:2007. An additional warning for Class 1M laser products. For diverging beams, this warning shall state that viewing the laser output with certain optical instruments (for example eye loupes, magnifiers, and microscopes) within a distance of 100 mm may pose an eye hazard. For collimated beams, this warning shall state that viewing the laser output with certain instruments designed for use at a distance (for example telescopes and binoculars) may pose an eye hazard.

Wavelength = 1.3/1.5 μm .

Maximum power = 30 mW.



*Caution - Use of controls or adjustments or performance of procedures other than those specified herein may result in hazardous radiation exposure.
*IEC is a registered trademark of the International Electrotechnical Commission.

Q&A About Fiber Optical Amplifier

Q: Can this amplifier pulsed signals?

A: It has been tested to amplify up to 100GHz digital data.

Q: Can this amplifier WDM signals?

A: It has been tested to amplify signals with DWDM wavelength spacing.

Q: Can this amplifier has a flat wavelength response?

A: Yes, by put gain flattening filters, that is an extra cost.

Q: If one puts a small signal into it, can it be amplified to the maximum output power indicated on the spec?

A: The amplifier is set as an analog mode whose output signal strength is approximately proportional to the input strength. It has a certain gain of about 40dB. There are two types: one is a preamplifier and a booster. One can use a preamplifier before the booster for weak signals, as done in electronic amplifiers.

Q: We have an existing amplifier. Can you duplicate it?

A: Yes, we can produce it with a seamless software interface.

Q: The control mode is selectable in the GUI, does this mean it can be operated in either APC, ACC, or CC mode? (i.e. can you support all 3 control modes in a single system)

A: MSA EDFA: APC, ACC & CC (AGC)
EYDFA (MSA & standard) : APC & ACC

Q: Do the MSA packages work with the Agiltron GUI?

A: Yes

Q: Do you have preamplifier with -35 and -40dBm input power?

A: Yes, available in different package.

Q: Does the Preamplifier come with APC or ACC control mode and which control mode achieves better receive sensitivity?

A: Under ACC mode, EDFA will amplify any input if you choose the always-on pump option.

Q: If we want to control the EDFA without the GUI, do you have a list of the RS232 commands?

A: It comes with each EDFAs.

Erbium Doped Fiber Amplifier: C-Band (1528 – 1565nm)



DATASHEET

Modes Description

The EDFAs have both ACC mode - automatic current control or constant current control and APC mode - automatic power control settable via GUI. In the ACC mode, the pump laser's current is set by the user and automatically locked by the EDFA to achieve a constant pumping current. The EDFA's output power is proportional to the input power and has output even though the input signal is weak. In the APC mode, the user sets the output power, and the EDFA automatically maintains the output constant in a feedback laser pump control way. When the input optical power fluctuates, the APC mode minimizes the fluctuation of the output power and is suitable for power type and line type EDFA.

Typical Spectrums

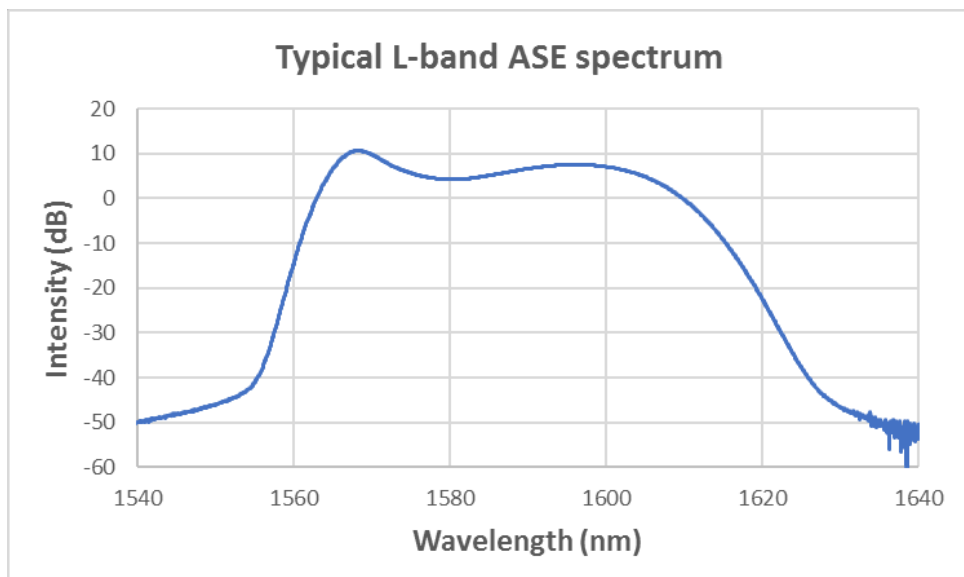
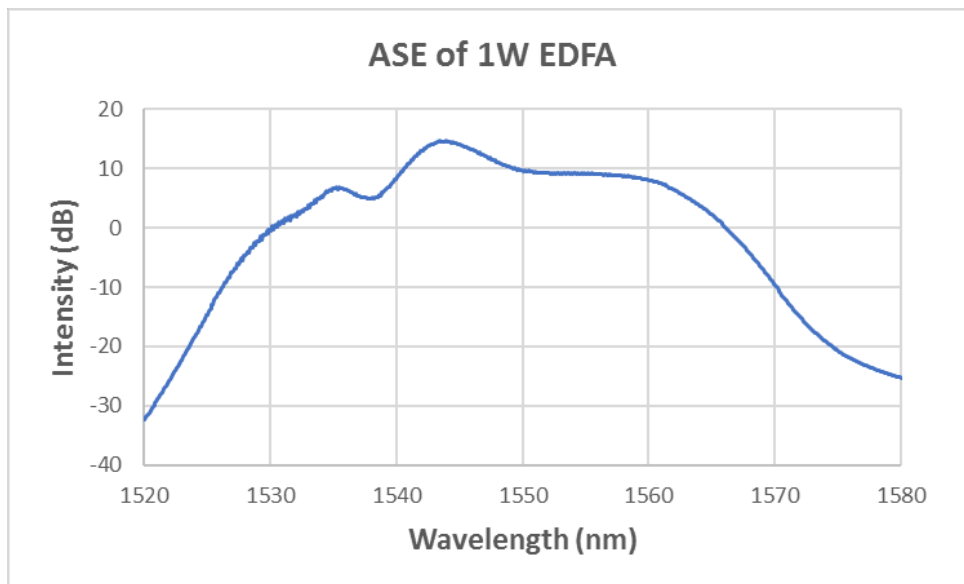

Erbium Doped Fiber Amplifier: C-Band (1528 – 1565nm)

DATASHEET

Typical Nanosecond Laser Pulse Amplification

- Source laser: 2.5kHz 200ns pulses with peak power 1.33mW
- Amplified 42dB by 23.5dBm EDFA;
- ASE floor is about 24dB lower than the peak power;

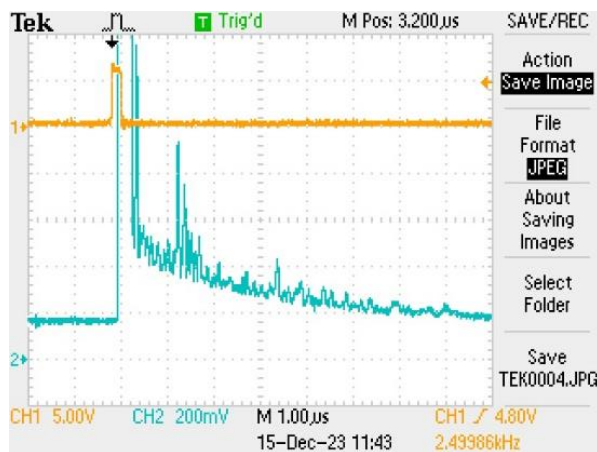
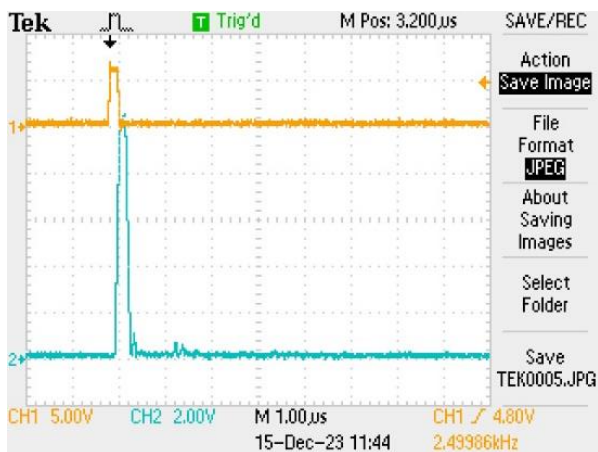

Gain Flattering Filter Effect

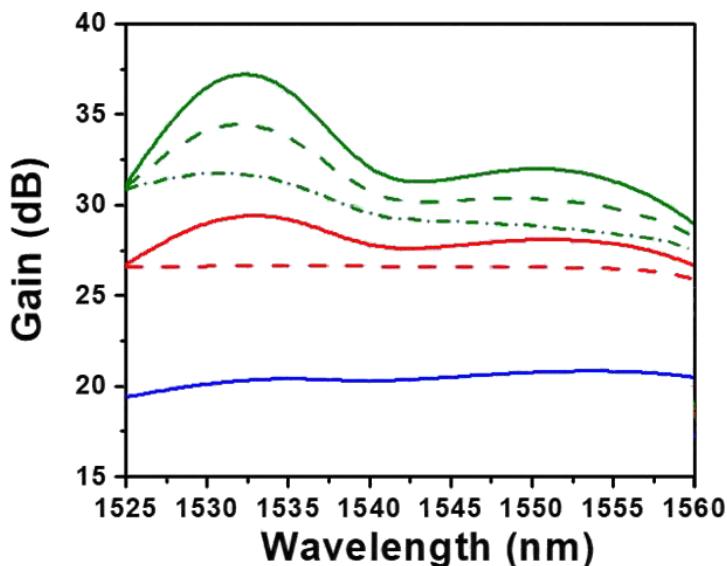

- 0 dBm Without Gain Flattering Filter
- -10 dBm Without Gain Flattering Filter
- - -10 dBm With One Gain Flattering Filter
- -20 dBm Without Gain Flattering Filter
- - -20 dBm With One Gain Flattering Filter
- . - . -20 dBm With Two Gain Flattering Filter