

Fiber-Fiber™ Optical Switch

Full 2x2 & 2x2 Bypass

(all fiber types, ultra-broadband, bidirectional)

(Protected by pending patents)



DATASHEET

[Return to the Webpage](#)

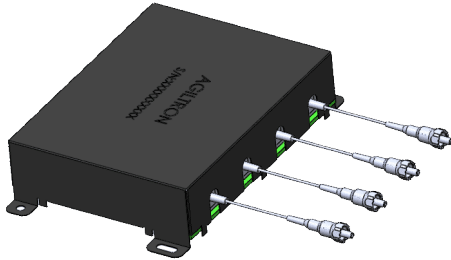

Features

- Low Optical Distortions
- High Isolation
- High Reliability
- Fail-Safe Latching
- Vibration Resistant
- Unmatched Low Cost

Applications

- Protection
- Instrumentation

The FF Series fiber optic switch connects optical channels by a micro-mechanical fiber to fiber auto-alignment platform and activated via an electrical relay. The advanced design significantly increase the performance, offering unprecedented low optical loss, little wavelength dependence with no coatings, high power handling, as well as unmatched low cost. Latching operation preserves the selected optical path after the driver signal has been removed. The switch has integrated electrical position sensors. The switch is bidirectional and conveniently controllable by 5V TTL.

Using no lens, the FF Series switch can accommodate all type of fibers, including SM, MM, PM, double cladding, bendable, large core, small core.

Lightpath in the device is bidirectional.

This switch uses a specially formulated index-matching liquid that does not generate fluorescent. The liquid fills a gap of less than 5 μm .

Specifications

Parameter	Min	Typical	Max	Unit
Wavelength	350		2500	nm
Insertion Loss ^[1]		1		dB
Wavelength Dependent Loss			0.1	dB
Polarization Dependent Loss			0.1	dB
Polarization Extinction Ratio ^[2]	18			dB
Return Loss	52	55		dB
	35 ^[3]			dB
Cross Talk	60 ^[3] / 65 ^[5]			dB
Switching Time		3		ms
Repeatability			± 0.1	dB
Durability	10^8			cycles
Repetition Rate			5	Hz
Operating Optical Power		0.5 ^[4]	0.5 ^[3]	W
Operating Voltage	4.5	5	5.5	VDC
Operating Current (Latching/Non-Latching)		30	60	mA
Switching Type	Latching / Non-Latching			
Operating Temperature	-40		80	°C
Storage Temperature	-50		90	°C

Notes:

- [1]. SM 28 Fiber, Excluding Connectors. For MM fiber with laser CPR<14.
- [2]. For PM fiber only
- [3]. For MM fiber with laser CPR<14
- [4]. For MFD $\geq 6\mu\text{m}$ core fiber
- [5]. For SM or PM fiber

Note: The specifications provided are for general applications with a cost-effective approach. If you need to narrow or expand the tolerance, coverage, limit, or qualifications, please [click this link](#):

Legal notices: All product information is believed to be accurate and is subject to change without notice. Information contained herein shall legally bind Agiltron only if it is specifically incorporated into the terms and conditions of a sales agreement. Some specific combinations of options may not be available. The user assumes all risks and liability whatsoever in connection with the use of a product or its application.

Rev 11/16/24

Fiber-Fiber™ Optical Switch

Full 2x2 & 2x2 Bypass

(all fiber types, ultra-broadband, bidirectional)



DATASHEET

Mechanical Dimensions (mm)

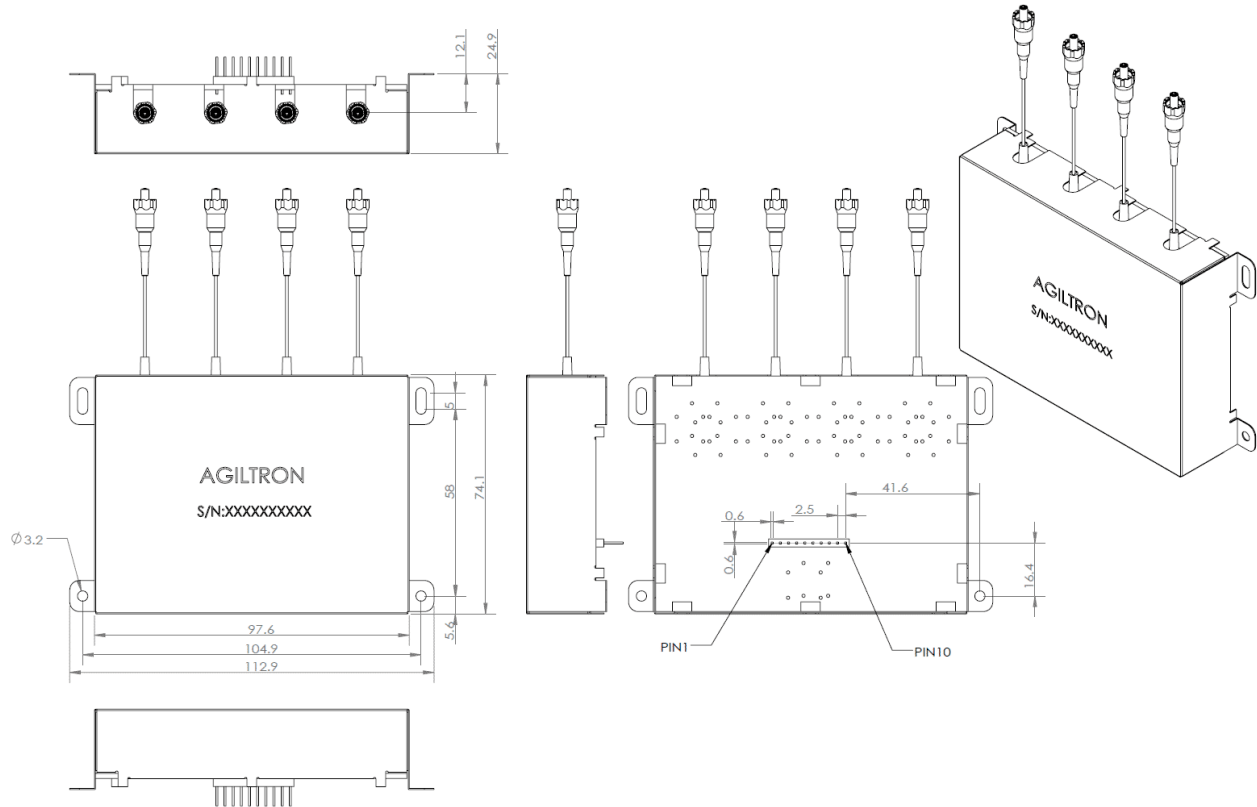

*Product dimensions may change without notice. This is sometimes required for non-standard specifications.

Electrical Connector Configurations

Agiltron offers a computer control kit with TTL and USB interfaces and Windows™ GUI. We also offer the RS232 interface as an option – please contact Agiltron sales.

Application Note: For the latching type, one can also apply a constant driving voltage that increases stability. The switches can also be driven by a pulse mode using Agiltron recommended circuit for energy saving.

Warning: The switch must be driven by the reference circuit otherwise the performance is unstable, due to the internal magnet that requires the current flow in the correct direction. The load is a resistive coil that is activated by applying 5V (draw ~ 40mA).

Latching Type

	switch 1		switch 2		switch 3		switch 4	
	Pin 1	Pin 2	Pin 3	Pin 4	Pin 5	Pin 6	Pin 7	Pin 8
Port 1 → Port 1`	H	L			H	L		
Port 1 → Port 2`	L	H					L	H
Port 2 → Port 1`			L	H	L	H		
Port 2 → Port 2`			H	L			H	L

Notes:

H – 4.5V

L – 0V

Empty – Don't care H or L

Non-Latching Type

	switch 1		switch 2		switch 3		switch 4	
	Pin 1	Pin 2	Pin 3	Pin 4	Pin 5	Pin 6	Pin 7	Pin 8
Port 1 → Port 1`	L	L			L	L		
Port 1 → Port 2`	L	H					L	H
Port 2 → Port 1`			L	H	L	H		
Port 2 → Port 2`			L	L			L	L

Notes:

H – 4.5V

L – 0V

Empty – Don't care H or L

Fiber-Fiber™ Optical Switch

Full 2x2 & 2x2 Bypass

(all fiber types, ultra-broadband, bidirectional)



DATASHEET

Ordering Information

Prefix	Type	Switch	Tested Wavelength ^[1]	Fiber Type	Fiber Cover	Fiber Length	Connector	Benchtop ^[2]
FFSW-	Full 2x2 = 22 2x2 Bypass = 2B	Latching = 2 Non-latch = 3	488 = 4 532 = 5 630 = 6 780 = 7 850 = 8 980 = 9 1060 = 1 1310 = 3 1550 = C 2000 = 2 Special = 0	Pick from below table	Bare fiber = 1 900um tube = 3 Special = 0	0.25m = 1 0.5m = 2 1.0m = 3 Special = 0	None = 1 FC/PC = 2 FC/APC = 3 SC/PC = 4 SC/APC = 5 ST/PC = 6 LC/PC = 7 Duplex LC/PC = 8 MTP = 9 LC/APC = A LC/UPC = U Special = 0	Non = 1 Yes = 2

[1]. The device is ultra-broadband limited by the fiber transmission. However, we only test at one selected wavelength to save cost. If customer needs to test at several wavelengths, the selection is special =0 with added cost.

[2]. The benchtop integrates the modulator, driver, and power supply. Front Panel: SMA 0-5V electrical control input port for precise modulation. Fiber input and output ports with standard FC/APC connectors. Back Panel: 100-240 VAC power input for global compatibility and a Power switch for easy on/off control. This all-in-one design simplifies setup and operation

Fiber Type Selection Table:

01	SMF-28	71	MM 50/125µm
02	SMF-28e	72	MM 62.5µm
03	Corning XB	73	105/125µm
04	SM450	74	FG105LCA
05	SM1950	75	FG50LGA
06	SM600	76	STP 50/125
07	Hi780		
08	SM800		
09	SM980		
10	Hi1060		
11	SM400		
12			
13			

Benchtop Box Mechanical Dimension

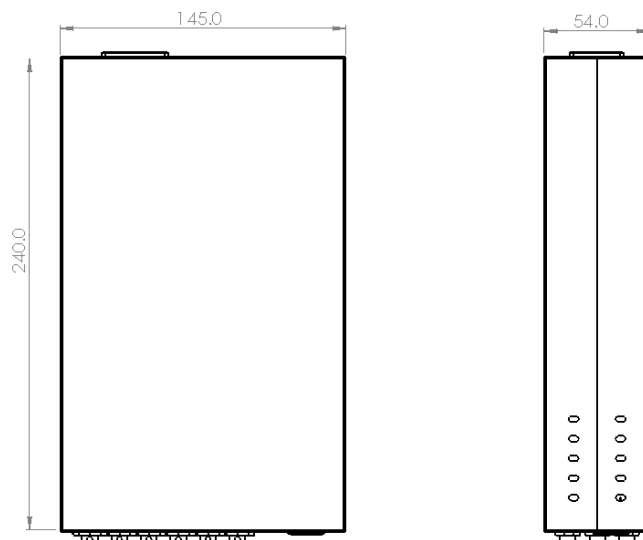

*Product dimensions may change without notice. This is sometimes required for non-standard specifications.

Fiber-Fiber™ Optical Switch



Full 2x2 & 2x2 Bypass

(all fiber types, ultra-broadband, bidirectional)

DATASHEET

Optical Path Diagram (two states)

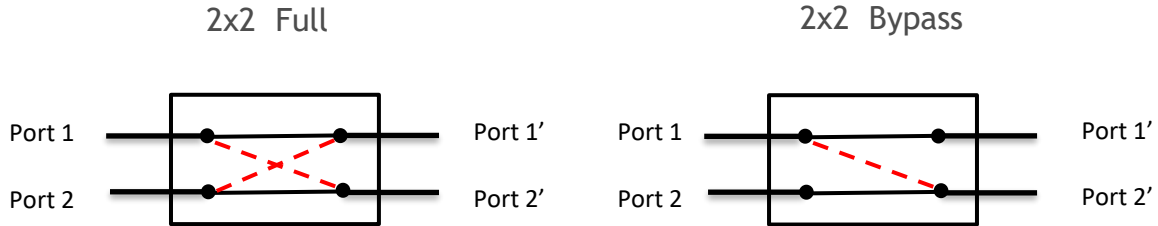

Driver Reference Design

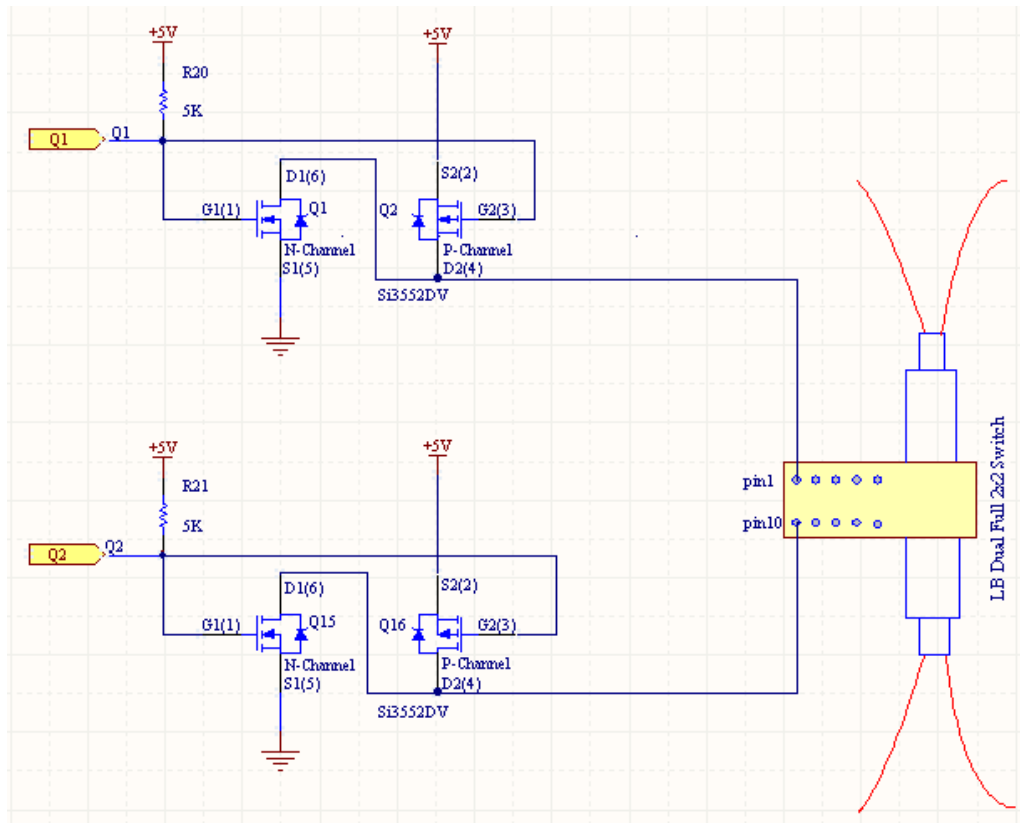

Fiber-Fiber™ Optical Switch

Full 2x2 & 2x2 Bypass

(all fiber types, ultra-broadband, bidirectional)



DATASHEET

Response Speed

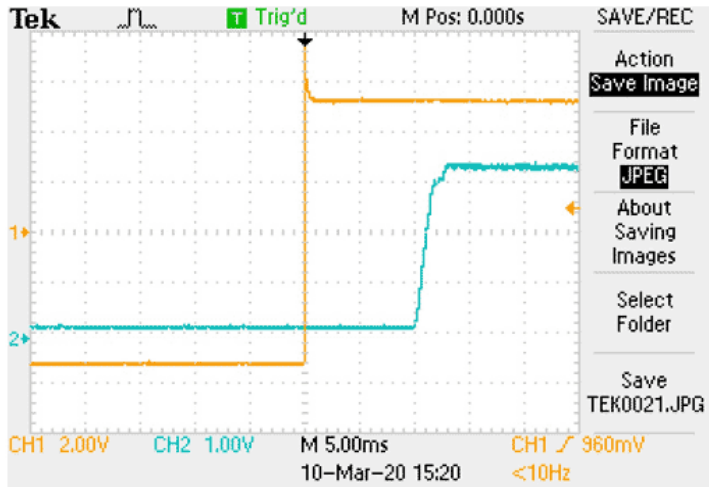

Rise

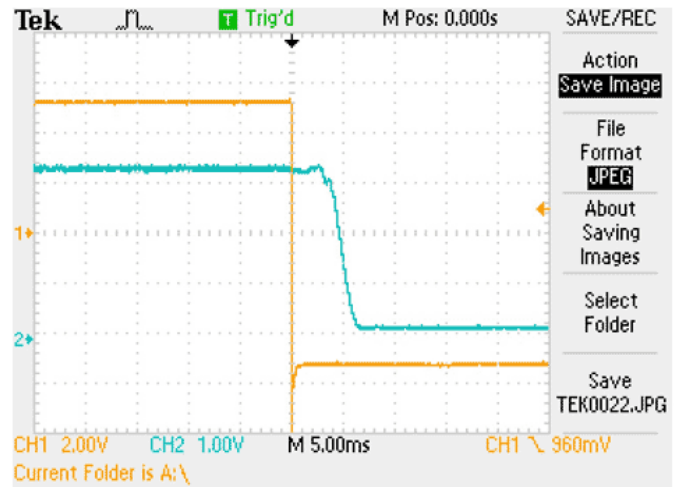

Fall

Typical Fiber Transmissions

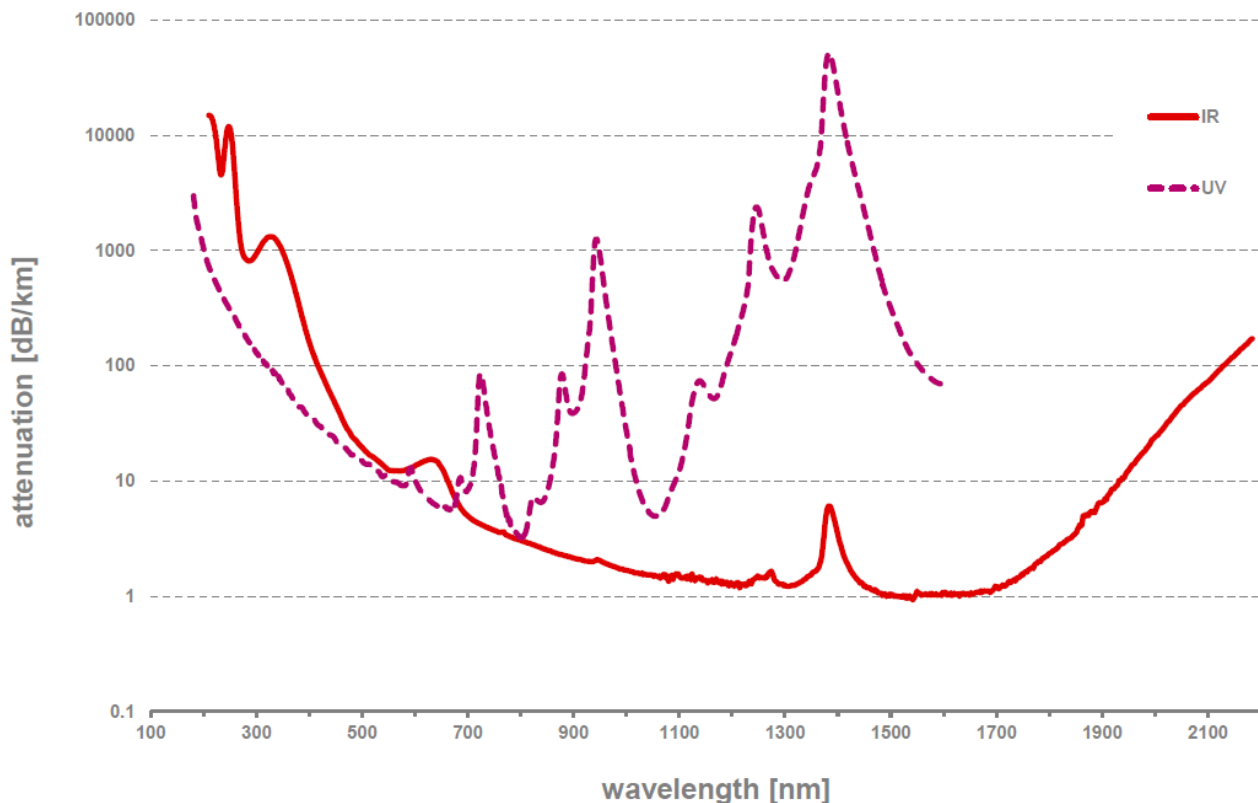

Fiber-Fiber™ Optical Switch

Full 2x2 & 2x2 Bypass

(all fiber types, ultra-broadband, bidirectional)



DATASHEET

Application Notes

Fiber Core Alignment

Note that the minimum attenuation for these devices depends on excellent core-to-core alignment when the connectors are mated. This is crucial for shorter wavelengths with smaller fiber core diameters that can increase the loss of many decibels above the specification if they are not perfectly aligned. Different vendors' connectors may not mate well with each other, especially for angled APC.

Fiber Cleanliness

Fibers with smaller core diameters (<5 μm) must be kept extremely clean, contamination at fiber-fiber interfaces, combined with the high optical power density, can lead to significant optical damage. This type of damage usually requires re-polishing or replacement of the connector.

Maximum Optical Input Power

Due to their small fiber core diameters for short wavelength and high photon energies, the damage thresholds for device is substantially reduced than the common 1550nm fiber. To avoid damage to the exposed fiber end faces and internal components, the optical input power should never exceed 20 mW for wavelengths shorter 650nm. We produce a special version to increase the handling by expanding the core side at the fiber ends.