

NanoSpeed™ Variable Fiber Optical Attenuator Single Stage

(SMF, PMF, High Power, Bidirectional)

(10W high power, continuous fiber of lossless, up to 10dB)



DATASHEET

[Return to the Webpage](#)



Features

- Solid-State
- High speed
- Ultra-high reliability
- Low insertion loss
- Compact

Applications

- Optical blocking
- Configurable operation
- Instrumentation

The Nano-speed Variable Fiber Optical Attenuator (NVOA) provides high-speed electrical control of optical power through a patent-pending configuration activated by a voltage control signal. Its solid-state optical crystal design eliminates mechanical movement and the need for organic materials, ensuring long-lasting durability and optimal performance. The NVOA Series Variable Optical Attenuators are engineered to meet demanding operational requirements, offering ultra-high reliability, rapid response times, and a compact footprint, as well as space qualification. The NVOA operates bidirectionally and is available in two configurations: Normally-transparent, where light passes through without voltage applied. Normally-opaque, where light is blocked until voltage is applied. The attenuation level is dependent on the operational stage, while the response speed is influenced by both the attenuation level and driver power (repetition rate). For lower attenuation levels, response times can reach up to the MHz range. Each NVOA unit is mounted on an electronic driving PCB board with a 0–5V control input, optimized for various repetition rates. Agiltron also offers customized electronic designs tailored to specific control requirements and applications.

Specifications

Parameter	Min	Typical	Max	Unit
Central wavelength ^[1]	960		2300	nm
Insertion Loss ^[2]	1260~1650nm	0.6	1.0	dB
	960~1100nm	0.8	1.3	
Attenuation Range ^[3]	18	22	32	dB
PDL (SMF VOA only)		0.1	0.3	dB
PMD (SMF VOA only)		0.1	0.3	ps
ER (PMF VOA only)	18	25		dB
Resolution		Continuous		dB
Return Loss	45	50	60	dB
Fiber Type	SMF-28, Panda PM, or equivalent			
Driver Repeat Rate	20kHz driver	DC	20	kHz
	100kHz driver	DC	100	kHz
Modulation rate ^[4]		0.1	5	MHz
Optic Power Handling ^[5]	Normal power VOA		300	mW
	High power VOA		20	W
Operating Temperature	-5		70	°C
Storage Temperature	-40		85	°C

Notes:

- [1]. Operation bandwidth is ± 25 nm approximately at 1550nm.
- [2]. Measured without connectors. For other wavelength, please contact us.
- [3]. Full attenuation is measured at 5kHz, which may be degraded at the high repeat rate.
- [4]. Special circuit for narrow frequency range, maximum modulation depth is 5~10%.
- [5]. Defined at 1310nm/1550nm. For the shorter wavelength, the handling power may be reduced, please contact us for more information.

Note: The specifications provided are for general applications with a cost-effective approach. If you need to narrow or expand the tolerance, coverage, limit, or qualifications, please [\[click this link\]](#):

Warning: The device mounted on the PCB is an OEM module designed for system integration only, not for general uses. Do not touch the PCB by hand. The electrical static can kill the chips even without a power plug-in, and unpleasant electrical shock may also be felt. For laboratory use, please buy a protected Turnkey system.

Legal notices: All product information is believed to be accurate and is subject to change without notice. Information contained herein shall legally bind Agiltron only if it is specifically incorporated into the terms and conditions of a sales agreement. Some specific combinations of options may not be available. The user assumes all risks and liability whatsoever in connection with the use of a product or its application.

Rev 10/21/24

© Photonwares Corporation

P +1 781-935-1200

E sales@photonwares.com

W www.agiltron.com

Information contained herein is deemed to be reliable and accurate as of the issue date. Photonwares reserves the right to change the design or specifications at any time without notice. Agiltron is a registered trademark of Photonwares Corporation in the U.S. and other countries.

NanoSpeed™ Variable Fiber Optical Attenuator Single Stage

(SMF, PMF, High Power, Bidirectional)

(10W high power, continuous fiber of lossless, up to 10dB)



DATASHEET

Mechanical Dimensions (mm)

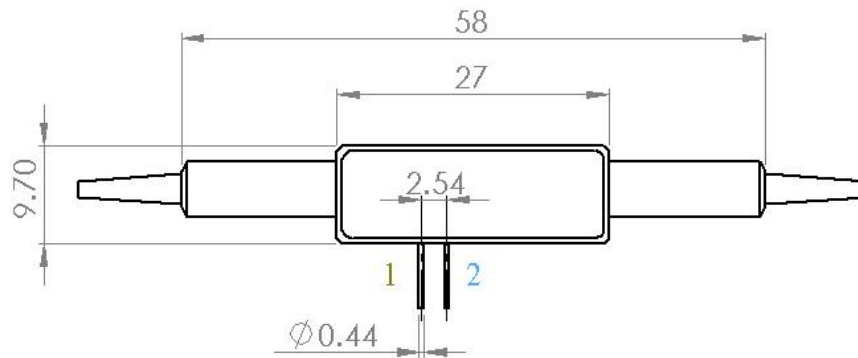
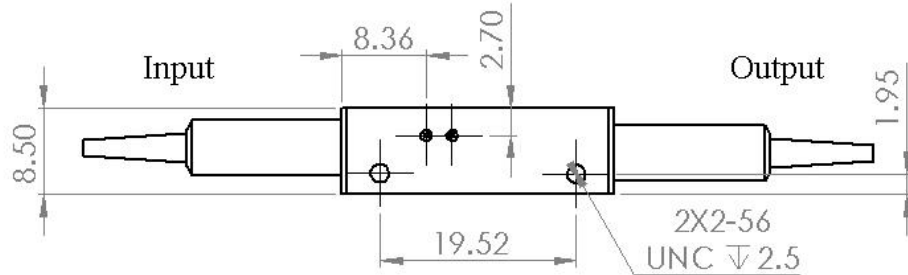

Normal Power VOA

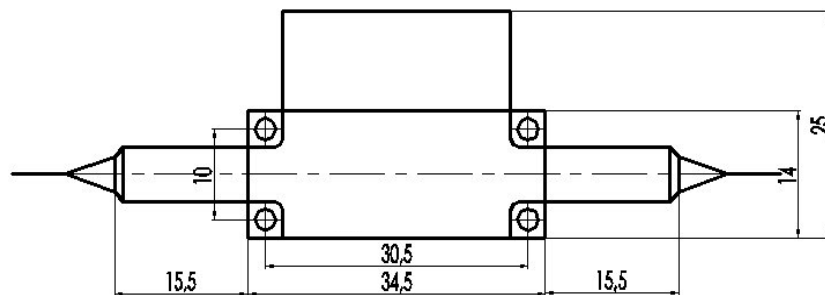
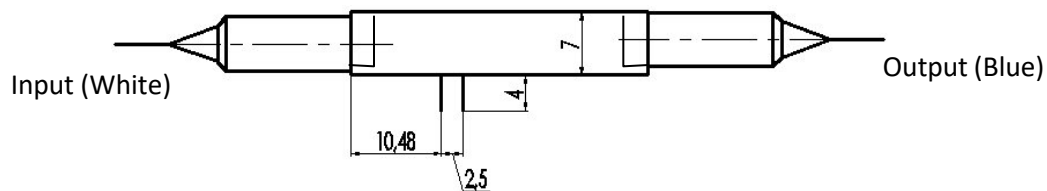

High Power VOA (Option 1, 0.5 < P < 2W)

*Product dimensions may change without notice. This is sometimes required for non-standard specifications.

NanoSpeed™ Variable Fiber Optical Attenuator Single Stage

(SMF, PMF, High Power, Bidirectional)

(10W high power, continuous fiber of lossless, up to 10dB)



DATASHEET

Mechanical Dimensions (mm)

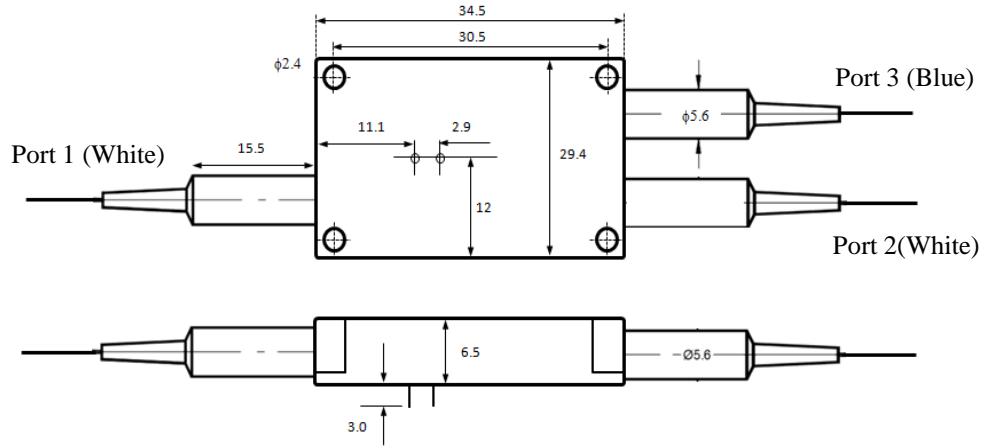

High Power VOA (Option 2, P ≥ 2W)

*Product dimensions may change without notice. This is sometimes required for non-standard specifications.

Typical Attenuation versus Voltage

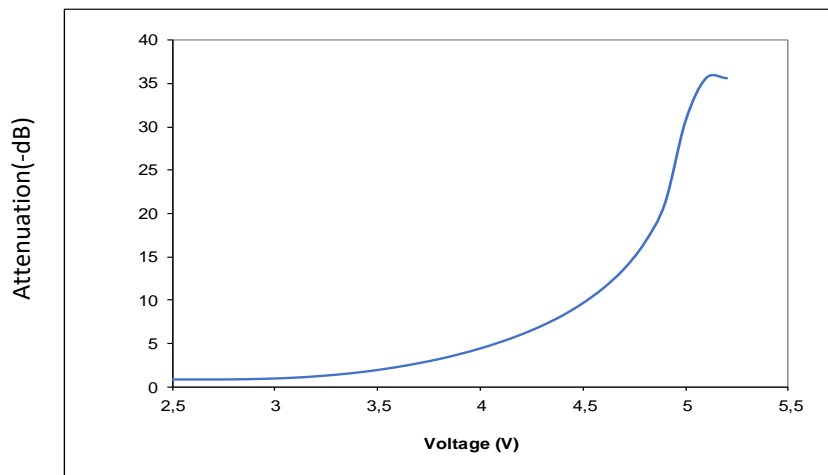

* Measured with Agiltron's NVDR driver

Driving Board Selection

Maximum Repetition Rate	Part Number (P/N)
20 kHz	NVDR-113235112
100 kHz	NVDR-112221112

Note: For customers that prefer to design their own driving circuit, they are responsible for the optical performance. For more technical information, please contact us.

NanoSpeed™ Variable Fiber Optical Attenuator Single Stage

(SMF, PMF, High Power, Bidirectional)

(10W high power, continuous fiber of lossless, up to 10dB)



DATASHEET

Typical High Speed Response

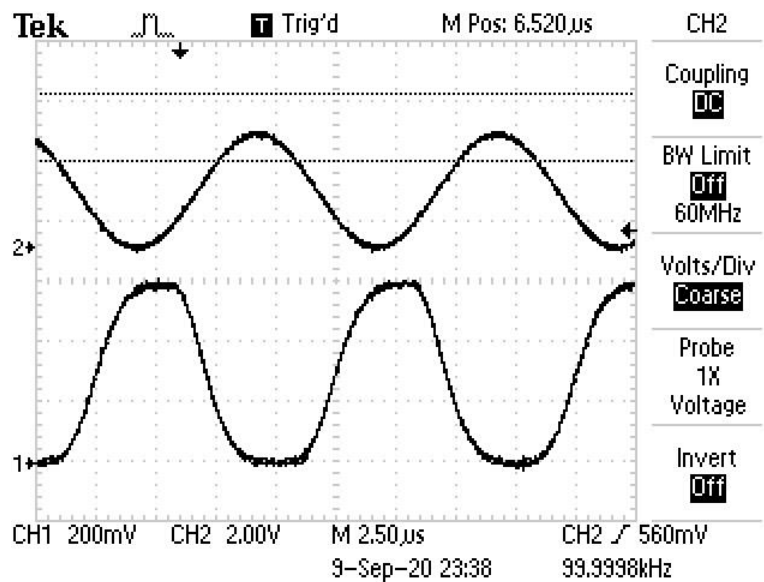
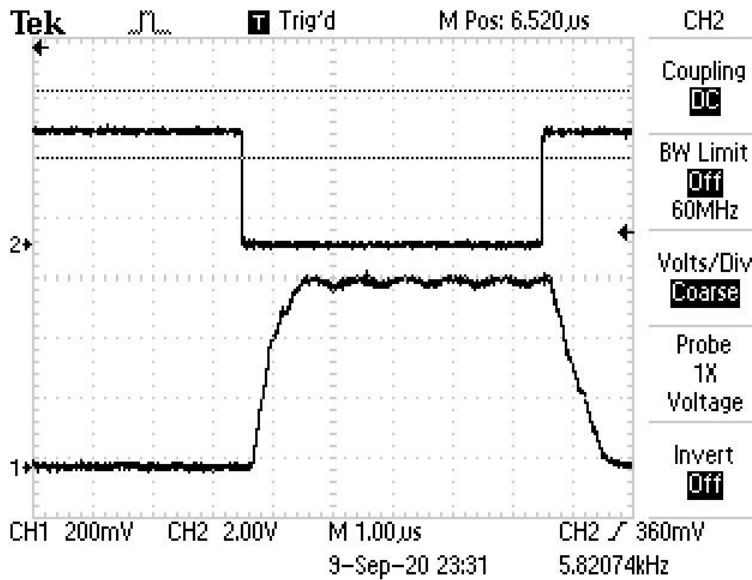

NanoSpeed™ Variable Fiber Optical Attenuator Single Stage

(SMF, PMF, High Power, Bidirectional)

(10W high power, continuous fiber of lossless, up to 10dB)



DATASHEET

Typical WDL @10dB attenuation

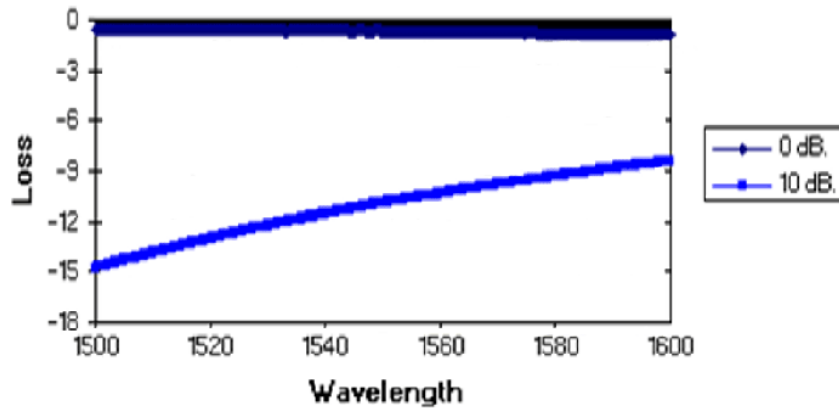

Ordering Information

Prefix	Type	Wavelength	Configuration	Stage	Fiber Type	Fiber Cover	Fiber Length	Connector ^[4]	ER	Benchtop
NVOA - ^[1]	Standard Power = 32	1060 nm = 1	Transparent = 1	1 = 1	SMF-28 = 1	Bare fiber = 1	0.25 m = 1	None = 1	Non = 1	Non = 1
NHOA - ^[2]	3dB-bias ^[3] = 33	L Band = 2	Opaque = 2		HI 1060 = 2	0.9mm tube = 3	0.5 m = 2	FC/PC = 2	>18 = 2	Yes = 2
	5W Power = 05	1310 nm = 3	Special = 0		PM 1550 = 5	Special = 0	1.0 m = 3	FC/APC = 3	>25 = 3	
	10W Power = 10	1410 nm = 4			PM 1400 = C		Special = 0	SC/PC = 4	>29 = 4	
	20W Power = 20	1550 nm = 5			PM 1310 = D			SC/APC = 5		
		1950 nm = 9			PM 980 = E			ST/PC = 6		
		2100 nm = 8			PM 1900 = 9			LC/PC = 7		
		Special = 0			PM 2000 = 8			LC/APC = 9		
					Special = 0			LC/UPC = U		
								Special = 0		

[1]. **NVOA** – Normal Power

[2]. **NHOA** – High Power

[3]. 3dB-bias version has the IL ~3dB, it has better linear response and larger modulation depth in compared with the standard version under a small driving power/voltage.

[4]. Please contact us for high power connectors.

Note:

“transparent” means no attenuation without applying a controlling voltage, the “opaque” means the highest attenuation without applying a controlling voltage.

NanoSpeed™

Variable Fiber Optical Attenuator Single Stage

(SMF, PMF, High Power, Bidirectional)
(10W high power, continuous fiber of lossless, up to 10dB)



DATASHEET

Q&A

Q: Does NS device drift over time and temperature?

A: NS devices are based on electro-optical crystal materials that can be influenced to a certain range by the environmental variations. The insertion loss of the device is only affected by the thermal expansion induced miss-alignment. For extended temperature operation, we offer special packaging to -40 ... 100 °C. The extinction or cross-talk value is affected by many EO material characters, including temperature-dependent birefringence, V_p , temperature gradient, optical power, at resonance points (electronic). However, the devices are designed to meet the minimum extinction/cross-talk stated on the spec sheets. It is important to avoid a temperature gradient along the device length.

Q: What is the actual applying voltage on the device?

A: 100 to 400V depending on the version.

Q: How does the device work?

A: NS devices are not based on Mach-Zander Interference, rather birefringence crystal's nature beam displacement, in which the crystal creates two different paths for beams with different polarization orientations.

Q: What is the limitation for faster operation?

A: NS devices have been tested to have an optical response of about 300 ps. However, practical implementation limits the response speeds. It is possible to achieve a much faster response when operated at partial extinction value. We also offer resonance devices over 20MHz with low electrical power consumption.

Operation Manual

1. Connect a control signal to the SMA connector on the PCB.
2. Attach the accompanied power supply (typically a wall-pluggable unit).
3. The device should then function properly.

Note: Do not alter device factory settings.

Application Notes

Fiber Core Alignment

Note that the minimum attenuation for these devices depends on excellent core-to-core alignment when the connectors are mated. This is crucial for shorter wavelengths with smaller fiber core diameters that can increase the loss of many decibels above the specification if they are not perfectly aligned. Different vendors' connectors may not mate well with each other, especially for angled APC.

Fiber Cleanliness

Fibers with smaller core diameters (<5 μm) must be kept extremely clean, contamination at fiber-fiber interfaces, combined with the high optical power density, can lead to significant optical damage. This type of damage usually requires re-polishing or replacement of the connector.

Maximum Optical Input Power

Due to their small fiber core diameters for short wavelength and high photon energies, the damage thresholds for device is substantially reduced than the common 1550nm fiber. To avoid damage to the exposed fiber end faces and internal components, the optical input power should never exceed 20 mW for wavelengths shorter 650nm. We produce a special version to increase the how handling by expanding the core side at the fiber ends.

NanoSpeed™ Variable Fiber Optical Attenuator Single Stage

(SMF, PMF, High Power, Bidirectional)

(10W high power, continuous fiber of lossless, up to 10dB)



DATASHEET

NanoSpeed™ VOA V_{π} Adjustment (operation instruction)

Electro-optical devices have a maximum amplitude or phase change that peaks at an applied voltage of V_{π} . Therefore, by adjusting the V_{π} the performance can be optimized for a specific wavelength or temperature. Below is an instruction to change the V_{π} .

Definition of Pins and Ports:

The picture shown here is a typical Agiltron NanoSpeed™ VOA mounted on the driver board.

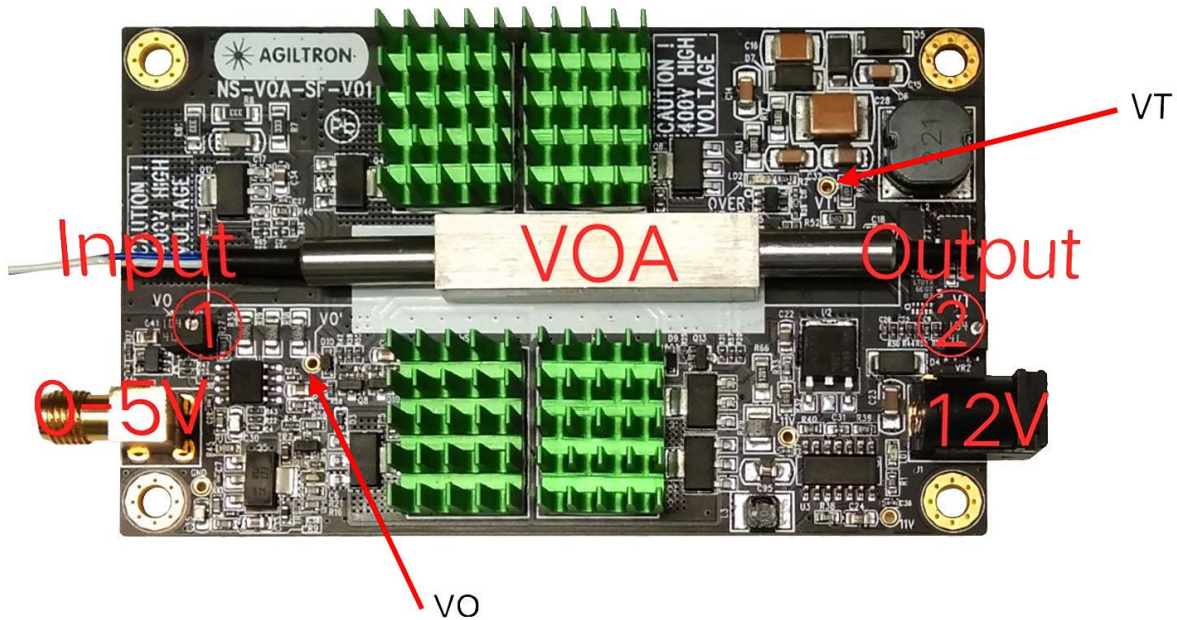

Setup procedure: (Factory has Pre-set the optimized parameters)

1. Connect fiber input to a light source and output to a power monitor.
2. Connect control signal to SMA connector. 0-5 V DC-100kHz sawtooth/sinusoidal wave.
3. Plug the 12 V power adapter into the unit's power outlet (110/220V).
4. For max attenuation adjustment, apply a 5V DC signal to the SMA connector, monitor output power level, and adjust potentiometer ② (clockwise to increase voltage) to get max output attenuation. Record this voltage value (V_{π}) from test point VT on board. Set VT value = $V_{\pi} + 2$ V.
5. Apply 2.5V DC signal to SMA connector, adjust potentiometer ① (Counterclockwise to increase voltage) at test point VO on board. Set VO = $1/2 V_{\pi}$

Warning:

**Don't touch the driving board during operation to avoid unpleasant high-voltage electric shock.
Avoid damaging by statics, especially in winter when the environment is dry.**