

Semiconductor Optical Amplifier (SOA)

1210nm, SM, PM, 22/23.5 dBm



DATASHEET

[Return to the Webpage](#)



Features

- 1210nm Optical Amplification
- Inline Optical Signal Boost

Applications

- Instrument
- Sensor
- Communication



The SOAB is a high-saturation-output-power, high-bandwidth, low-noise booster optical amplifier. It features a highly efficient InP/InGaAsP Quantum Well (QW) layer structure and a reliable ridge waveguide design, ensuring robust performance. The amplifier is housed in a standard 14-pin butterfly package, complete with an integrated thermoelectric cooler (TEC) and thermistor for precise thermal management. The SOAB is polarization-insensitive, amplifying all polarization states, making it an excellent choice for in-line amplification. It is available with either single-mode (SM) or polarization-maintaining (PM) fiber pigtailed models, both terminated with FC/APC connectors. For PM-fiber-pigtailed models, the connector key is aligned to the slow axis. Options include configurations with no isolators or polarization-insensitive isolators at the input, output, or both, to eliminate reflection induced noise. The SOAB provides a versatile and reliable solution for optical amplification needs.

The basic working principle of an SOAB is the same as a semiconductor laser but without feedback. SOABs amplify incident light through stimulated emission. When the light traveling through the active region, it causes these electrons to lose energy in the form of photons and get back to the ground state. Those stimulated photons have the same wavelength as the optical signal, thus amplifying the optical signal.

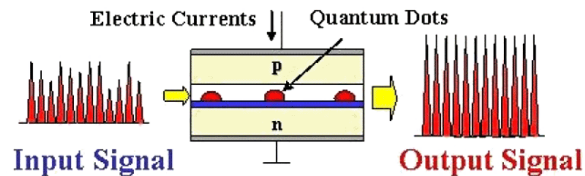

Specifications

Parameter	Min	Typical	Max	Unit
Operating Current		1200	1300	mA
Center Wavelength ^[1]	1185	1205	1225	nm
Optical 3 dB Bandwidth	75	82		nm
Saturation Output Power @ -3 dB ^{[2], [3]}	22	23.5		dBm
Small Signal Gain @ P _{IN} = -20 dBm ^{[2], [3]}	18	20.5		dB
Gain Ripple (RMS) @ I _{op} ^[2]		0.01	0.3	dB
Noise Figure ^{[2], [3]}		8	10	dB
Forward Voltage ^[2]		1.8	2.4	V
TEC Operation		25	50	°C
TEC Current		0.8	1.5	A
TEC Voltage		1.0	4.0	V
Thermistor Resistance		10		kΩ
Operating Current			1300	mA
Optical Output Power, CW			500	mW
Chip Temperature (TEC)	10		30	°C
Case Temperature	0		50	°C

Notes:

[1]. This is the center wavelength of the amplified spontaneous emission (ASE), and is not necessarily the operating wavelength. An operating wavelength of 1210 nm was selected for testing to yield the specified saturated output power (P_{SAT}).

[2]. At I_{op}.

[3]. At 1210 nm

Rev 02/13/25

© Photonwares Corporation

[+1 781-935-1200](tel:+17819351200)

sales@photonwares.com

www.agiltron.com

Semiconductor Optical Amplifier (SOA)

1210nm, SM, PM, 22/23.5 dBm



DATASHEET

Mechanical Dimension (mm)

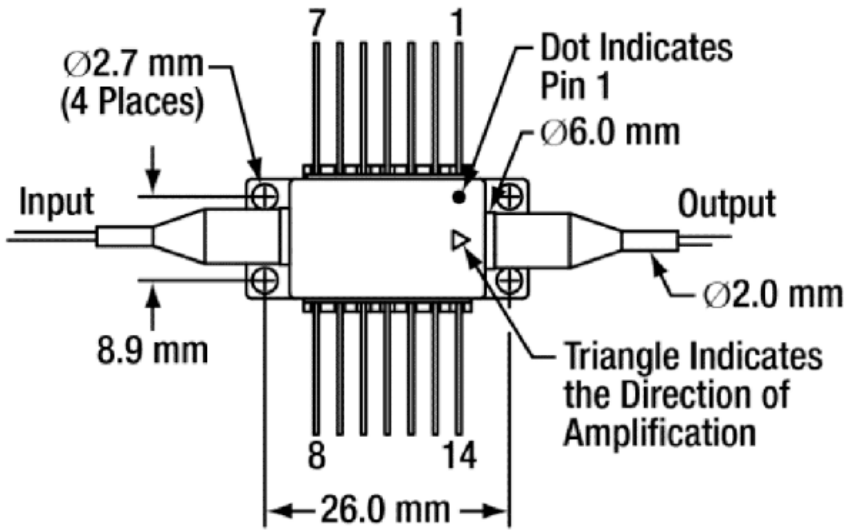

PIN	Function
1	TEC (+)
2	Thermistor
3	NC
4	NC
5	Thermistor
6	NC
7	NC
8	NC
9	NC
10	Device Anode (+)
11	Device Cathode (-)
12	NC
13	Ground
14	TEC (-)

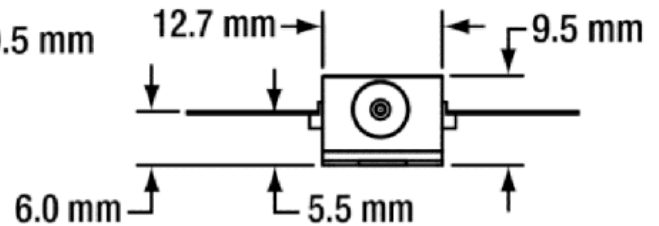
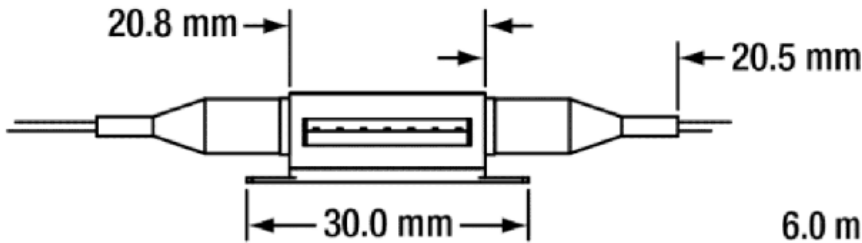

*Product dimensions may change without notice. This is sometimes required for non-standard specifications.

Ordering Information

Prefix	Wavelength	Output Power	Isolator	TEC Cooling	PD	Fiber Type	Fiber Buffer	Fiber Length	Connector	Driver ^[1]
SOAB-	1210nm = 21 Special = 0	22dBm = 1 23.5dBm = 2	Non = 1 Output = 2 Input = 3 Output/Input = 3	Yes = 2	Yes = 2	HI1060 = 6 PM980 = 9 Special = 0	0.9mm Tube = 3 Special = 0	1.0 m = 1 Special = 0	FC/APC = 3 Special = 0	Non = 1 Benchtop = 2 Module = 3 Kit = 4

Note:

[1]. All Drivers are plug-n-play with a power supply provided. For the **Kit**, the diode mount is pre-configured to match the diode.

Semiconductor Optical Amplifier (SOA)

1210nm, SM, PM, 22/23.5 dBm



DATASHEET

Typical Spectrum (SM)

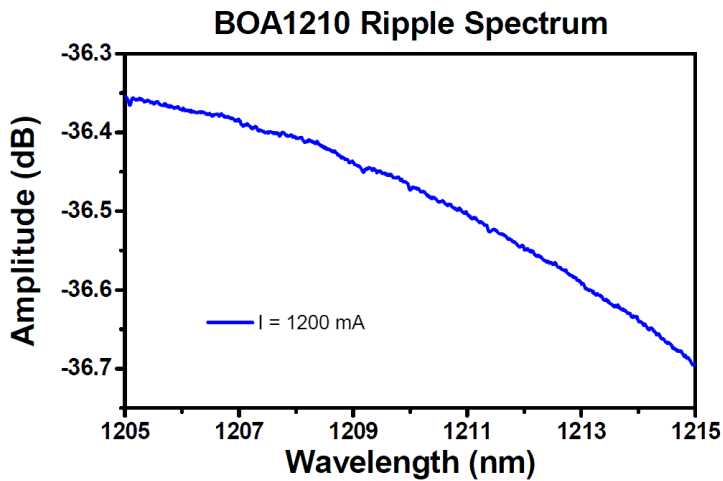
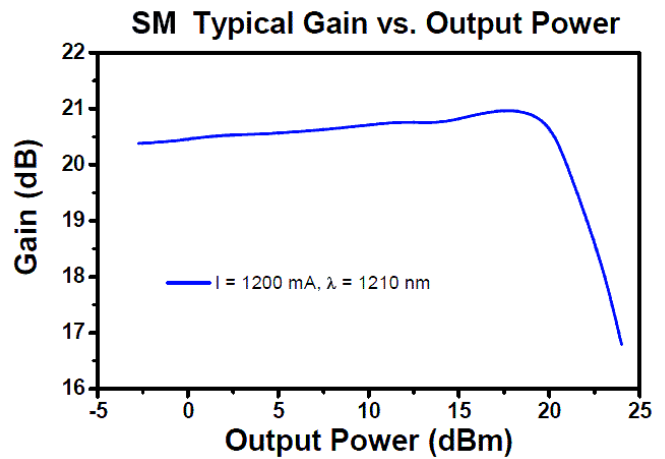
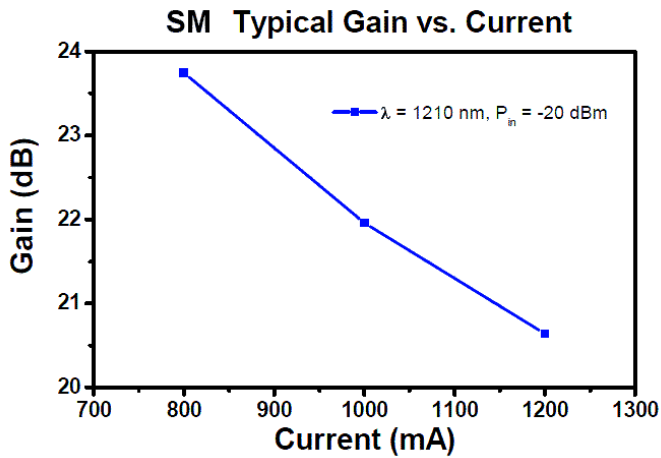
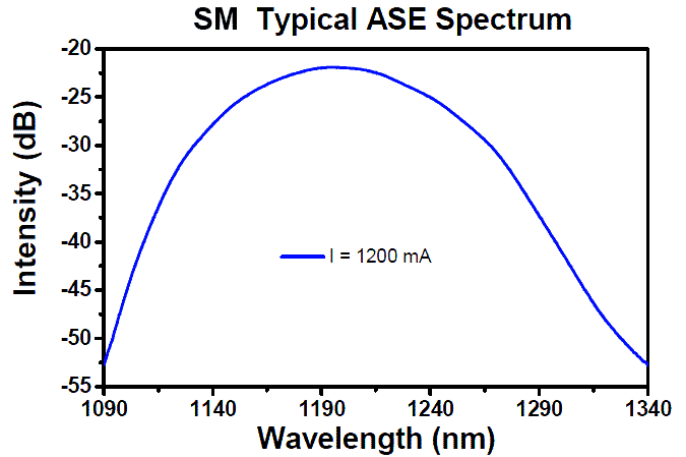
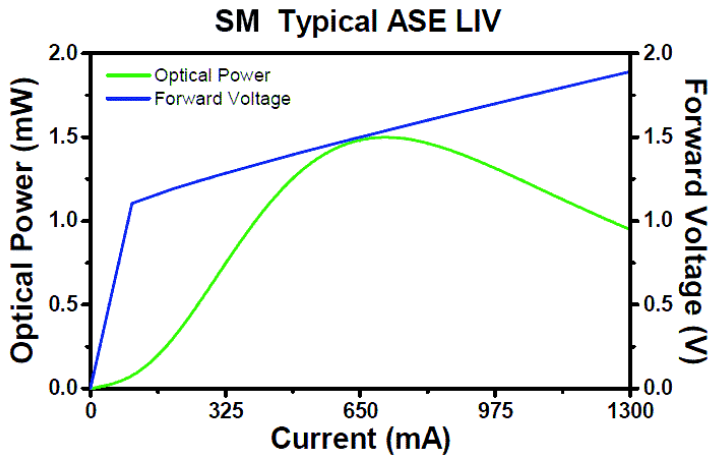

Semiconductor Optical Amplifier (SOA)

1210nm, SM, PM, 22/23.5 dBm



DATASHEET

Typical Spectrum (PM)

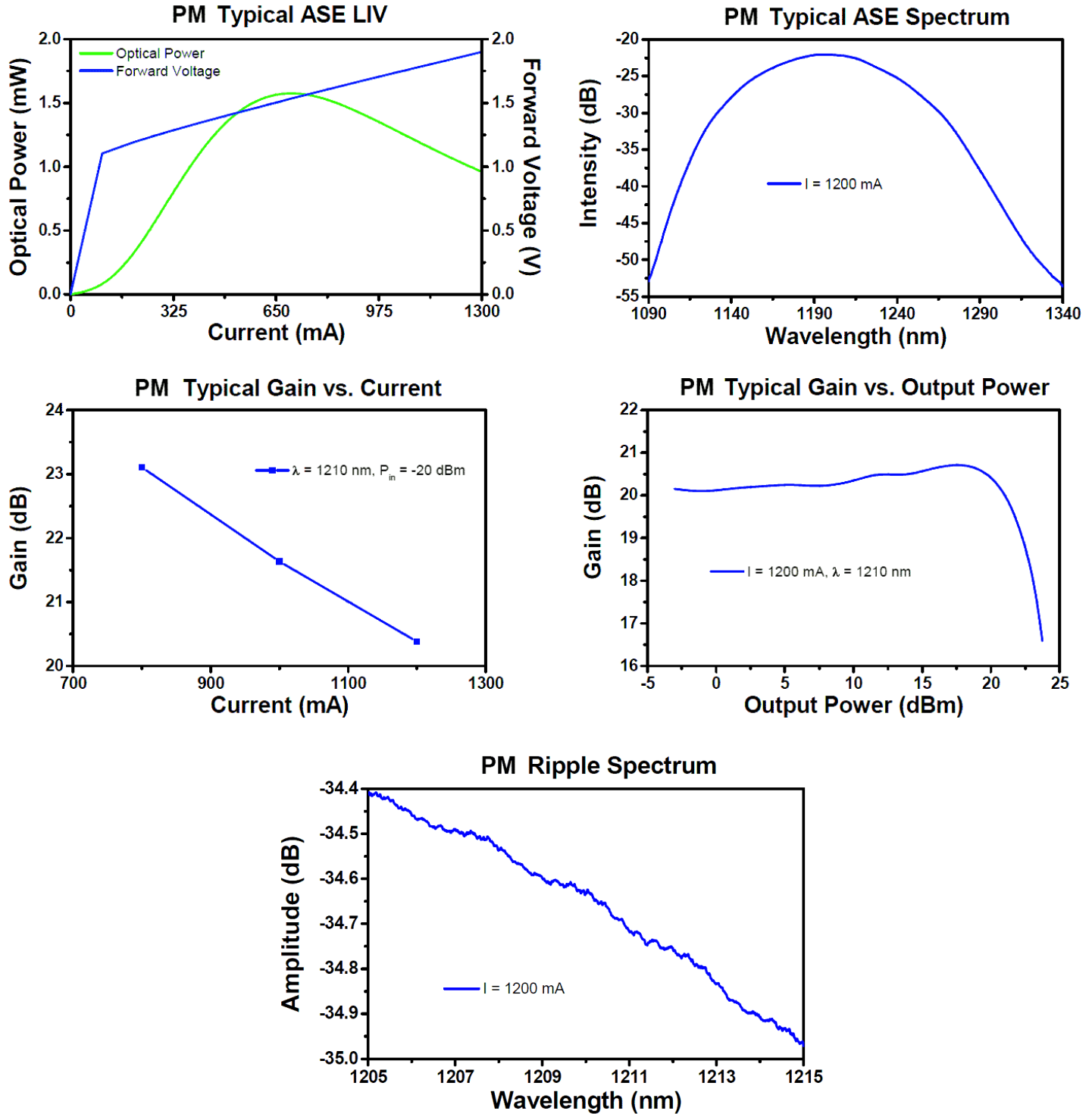

Semiconductor Optical Amplifier (SOA)

1210nm, SM, PM, 22/23.5 dBm



DATASHEET

Benchtop Matching Laser Diode Driver



Agiltron cost-effective LDCB series benchtop control kit is designed for easy laser diode mounting and precise control. It incorporates a high-precision, low-noise auto-feedback drive electronics to ensure constant output power or a constant driving current and an integrated temperature control unit maintains optimal operating conditions. The system provides up to 1A driving current and up to 2A TEC cooling current. Each system features a front fiber output connector. The user interface includes an intuitive LCD display for independent control of output power and temperature via two front rotating knobs. The LDCB also includes a universal power supply compatible with 100 to 240 VAC. The LDCB has a built-in isolator option to prevent reflection-induced laser emissions instability. The LDCB is designed as a laser diode and TEC controller kit for customer to install laser diode. It has three types of pluggable laser mounts of butterfly, DIL, and TOCAN. The TOCAN mount contains an external TEC that maintains a constant temperature for wavelength stability.

For details please click: <https://agiltron.com/product/laser-diode-tec-controllers-benchtop-kit/>

Turn-Key Module Matching The Laser Diode



The Agiltron LDCM series laser source module is designed for OEM applications and features all-in-one high reliability and highly stable laser output. The LDCM contains high-precision, low-noise, auto-feedback laser diode drive electronics to ensure constant output power or driving current and an integrated temperature controller that maintains optimal operating conditions. An optional fiber optical isolator can be integrated to prevent reflection-induced laser emission instability, which is essential for achieving highly stable lasers. Agiltron produces isolators from 370nm to 2600nm. The system provides up to 1A driving current and up to 2A TEC cooling current. Each unit features a single FC/APC connector output and two front rotating knobs for independent setting of laser output power and temperature. A toggle switch allows selection between constant current control mode and feedback constant output power mode.

For details please click: <https://agiltron.com/product/laser-diode-tec-controllers-module/>

Laser Driver Kit



Agiltron cost-effective LDCD series module control kit is designed for easy laser diode mounting and precise control. It incorporates a high-precision, low-noise auto-feedback drive electronics to ensure constant output power or a constant driving current and an integrated temperature control unit maintains optimal operating conditions. The system provides up to 1A driving current and up to 2A TEC cooling current. It has three types of pluggable laser mounts of butterfly, DIL, and TOCAN. The TOCAN mount contains an external TEC that maintains a constant temperature for wavelength stability. It comes with cables to connect between the mounting module to the driving module, making integration convenient.

For details please click: <https://agiltron.com/product/laser-diode-tec-controllers-compact/>

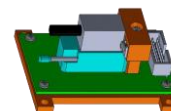
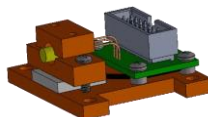
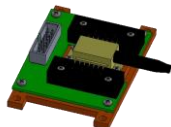

Semiconductor Optical Amplifier (SOA)

1210nm, SM, PM, 22/23.5 dBm



DATASHEET

Caution Electrostatic Sensitivity



- Never touch laser diode and the module using hands
- Always use protections when handle a laser diode
- Recommend mounting the laser diode using an ionic gun and ESD finger cots



Laser Safety

This product meets the appropriate standard in Title 21 of the Code of Federal Regulations (CFR). FDA/CDRH Class 1M laser product. This device has been classified with the FDA/CDRH under accession number 0220191. All versions of this laser are Class 1M laser products, tested according to IEC 60825-1:2007 / EN 60825-1:2007. An additional warning for Class 1M laser products. For diverging beams, this warning shall state that viewing the laser output with certain optical instruments (for example eye loupes, magnifiers, and microscopes) within a distance of 100 mm may pose an eye hazard. For collimated beams, this warning shall state that viewing the laser output with certain instruments designed for use at a distance (for example telescopes and binoculars) may pose an eye hazard.

Wavelength = 1.3/1.5 μm .

Maximum power = 30 mW.



*Caution - Use of controls or adjustments or performance of procedures other than those specified herein may result in hazardous radiation exposure.

*IEC is a registered trademark of the International Electrotechnical Commission.